

joloda.com

joloda
hydraroll

LIGHTENING LOADS

WORKING IN
PARTNERSHIP WITH



skate & track
systems





For more than 60 years, Joloda Hydraroll Ltd has been manufacturing the world-famous 'Joloda Skate'.

Production of the skate began in Liverpool, UK, in 1962 and since then; over 275,000 skates have helped customers all over the world making light work of moving heavy loads.

We are immensely proud of the fact the transport industry has adopted the name 'Joloda' as the brand name as the go-to skate.

contents

An Introduction...	4	The Paper Industry	12	Aluminium Skate Technical Illustration	21
Who, What and Why?	5	Great British Design and Quality	13	Aluminium Skate Dimensions	22
How Does It Work?	6	Sustainability at the Heart	14	Installations	23
The Benefits	7	Case Study	15	Videos	25
The World Renowned Skate	8	Introducing the Steel Skate	16	Why Choose Us?	26
You Spoke, We Listened	9	Steel Skate Technical Illustration	17	About Us	28
A Skate for Life	10	Steel Skate Dimensions	18	Global Leaders	29
Handling Pallets, with Ease	11	Introducing the Aluminium Skate	20	Let's Chat	30

an introduction...

Joloda Hydraroll's Skate & Track system is still one of the world's leading truck loading systems 60 years on. Awarded the prestigious British Design Award in 1977, the Skate & Track system has enabled customers worldwide to load/unload pallets and newsprint paper rolls safely and quickly. Did you know that over 1,000 trucks are loading/unloading with this system in Japan?

Companies such as UPM Kymmene, Aylesford Newsprint, Allied Bakeries and Dometic Corporation (in the USA) and many more have adopted the Skate & Track system to handle materials as part of their load and unloading processes due to its durability, reliability and capabilities to safely manoeuvre loads up to 3.5 tonnes.

BMW's manufacturing and assembly plant in Germany has been using the system for over 10 years to unload various kinds of car components, such as exhausts and bumpers, into their production facility's docks to aid their Just-in-Time (JIT) assembly processes.

The design and methodology in principle are simple; our skates are laid in recessed tracks in either a trailer or dock floor and when a handle is connected (by simply pushing down), the load is raised. When raised, the load is 'live' and can be freely pushed up and down the length of the tracks from a trailer into the loading dock.

The skates include a manual and automatic braking system, a self-centring mechanism and benefit from minimal maintenance, as the system cleans itself when it is in use. Skates don't rely on utilities, such as power or compressed air, which mean they can be used anywhere.

Our Skate & Track system has the potential to significantly reduce loading times, increase load volumes and create big savings on labour and forklift operation costs. Our Skate & Track System is simple, safe and economical and is trusted by thousands of people and businesses around the world make as their go-to loading and unloading solution for lightening loads.

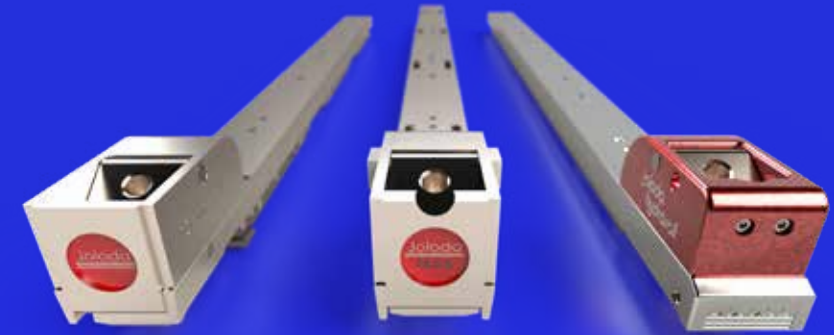

who, what and why?

Who Should Use a Skate & Track Loading System?

The Joloda Hydraroll Skate & Track manual loading systems are specifically used by companies that handle pallets and/or paper reels. It eliminates the need for a forklift or pallet truck to enter the cargo space.

Our Skate & Track system enables fast and safe loading and unloading from the back of a trailer or container. For clients who use heavy or over width pallet loads, who have limited space, for example, no dock levellers, the Skate & Track loading system is the ideal solution.

What is a Skate & Track Loading System?

Moving pallets or paper reels? This manual truck pallet loading and unloading solution easily shift heavy loads using a set of manually operated skates. Joloda Hydraroll's skates run in special tracks that are built into the trailer or container floor.

Ideal for moving pallets, slip sheets, drums, newsprint rolls, heavy and large machinery into or out of trucks and light vehicles, the Skate & Track is a cost-effective manual alternative to an automatic loading system.

Operators can simply and easily push pallets inside the truck to load or pull them towards the rear to unload without the forklift ever needing to enter the vehicle.

Why Choose a Skate & Track Loading System?

- Fast and easy handling of heavy goods without forklifts going into the cargo space
- Skates can lift and load reels/pallets up to 3.5 tonnes
- Maximum space utilisation and no product damage
- Minimum maintenance – a self-cleaning system
- 275,000 systems operating in over 30 countries worldwide for over 60 years

how does it work?

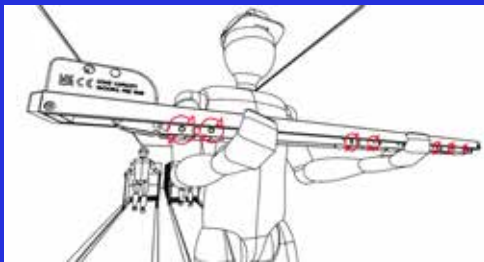

1. SKATES IN VEHICLE



2. SKATES PLACED IN TRACK

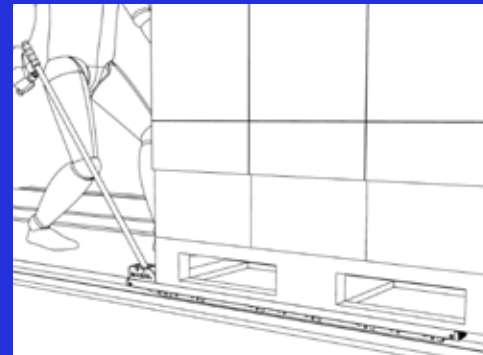

3. SKATES UNDER LOAD

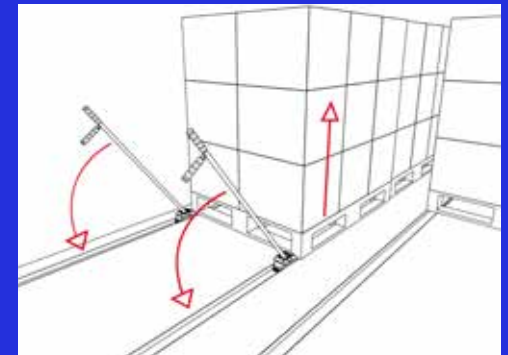

4. LOAD RAISED



5. LOAD PULLED OUT



6. LOAD PUSHED IN

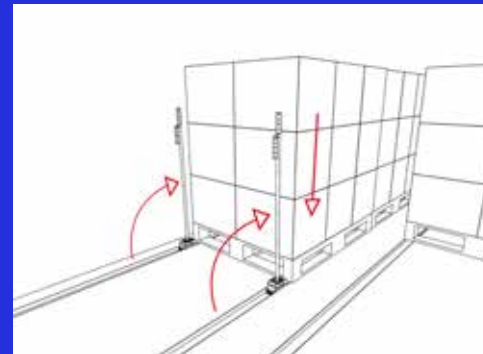

7. LOAD LOWERED

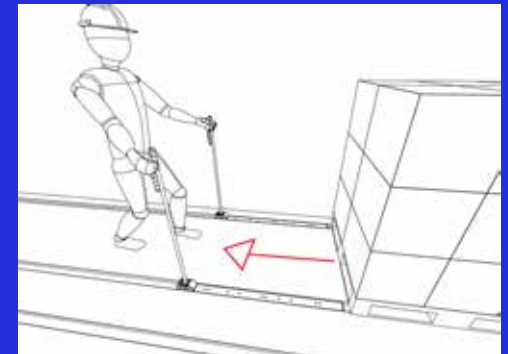

8. SKATES REMOVED

the benefits



EFFORTLESS TRUCK LOADING



NO TIME WASTED

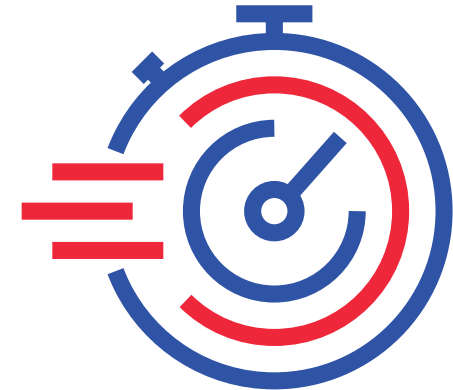

VERSATILE LOADING SYSTEM

the world-renowned skate

Joloda Hydraroll's brand has become the go-to brand name when it comes to high-quality material handling equipment when carrying out loading and unloading processes.

The brand is a synonym for highly engineered loading systems, which are durable, have been proven and are now world-renowned for safely handling pallets and bulky items, such as paper reels.

We have specifically and especially developed a range of Skate & Track systems that solve different loading and unloading challenges faced on different sides of the world.

Europe & the Americas

In the Western World, the Skate & Track system has become the standard loading solution for the handling and transportation of heavy-weight paper reels in a safe and controlled manner.

Asia

Whilst in the Eastern World, specifically in countries such as Japan and Korea, where pallet trucks are infrequently found in vehicles, the Skate & Track system is the standard loading solution for everything from fruit and veg to bulky palletised goods.



you spoke, we listened

At Joloda Hydraroll, our customers come first, listen to their problems and devise comprehensive solutions.

Handle

Our range of Skate & Track systems have the most advanced handle design to date, it is the only skate on the market where the handle can be used for both pushing and pulling loads, making it easier to manoeuvre loads.

Lifting Heights

With a range of different lifting heights, including a low lift, a heavy-duty, a heavy-duty max and an aluminium skate.

Weights

Our skates are also capable of lifting a variety of weights too, from 1,600kg to 3,500kg. So whatever you need to load, or how bulky it is, Joloda Hydraroll's skate is your ideal lifting tool.

One-off Specials

If you've got a lifting problem, we've got a solution. We are accustomed to manufacturing one-off special editions of our skates for unique applications, for example very long pallets.

We recently redeveloped our skate to accommodate pallets up to 4m in length.



a skate for life

When we say a skate for life, we really do mean a skate for life!

Our skates have stood the test of time and outperformed other skates that have found their way onto the market today. We're the pioneers in loading solutions and when you buy a genuine, Joloda Hydraroll skate, you'll receive a thoroughly engineered, and high quality manufactured skate that's been on the market for over 60 years.

Rigorously Tested

We rigorously test our Skate & Track systems to the point of destruction so we know and understand their capabilities.

12-Month Warranty

As standard, all our skates come complete with a 12-month

warranty. This reassures you that when you buy a Joloda Hydraroll product; you're going to receive the most reliable skate on the market.

Servicing and Maintenance

Our skates are easy to maintain and provide you with a stress-free loading tool, this is because they're manufactured with no oils, lubricants or grease. Skates are ready to go once they're out of the box.

As with any engineering solution, maintenance is key to prolonging longevity. When skates are properly carefully maintained, they are easily capable of exceeding the predicted engineering life-span of 15 years. We often sell spares to customers who have skates over 20 years of age



BEFORE



AFTER

handling pallets, with ease

Our Skates & Track solutions to many transport companies who, for different reasons, do not use pallet handling equipment inside their vehicles. Our skates enable the operator to move the heaviest pallets inside a vehicle in a safe and controlled manner.

Our Skate & Track systems are available in a variety of different lengths, which can be specified for certain types of pallets. Typical pallets our system is used to safely manoeuvre include:

Euro Pallets



Sizes: 1200mm x 800mm



CHEP Block Pallets



Sizes: 1200mm x 1000mm



Plastic Pallets

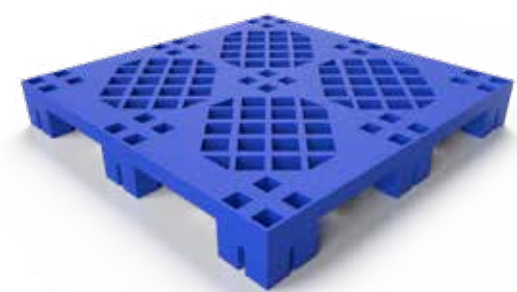

Sizes: 800-1219mm x 1016-1200mm

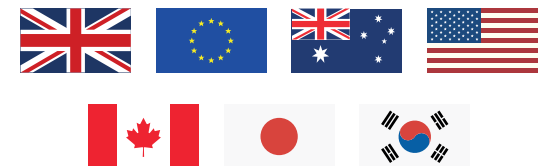

the go-to solution for the paper industry

For decades now, the Skate & Track system has been and will continue to be for many more years, the preferred loading solution for transport companies who load and move paper reels.

Over the years, the reels became taller and heavier and in line with the development of reels, we redesigned and re-engineered our skate to accommodate increased load capacities.

We launched the Heavy-Duty Max Skate is specifically for this application. Our Heavy-Duty Max Skate has a lifting capacity of 3,500kg, per pair and a lifting height of 19mm. This enables transport companies to safely lift and move even the heaviest reels.

Our Heavy-Duty Max Skate is available for use with both steel and aluminium tracks, too.



EXAMPLE OF LOADED PAPER REELS IN TRAILER

Great British design and quality

In 1962, Joloda Hydraroll's Skate & Track system was invented and has since gone on to become renowned across the world. In 1977, we were awarded the prestigious 'British Design Award' for the system.

Our skates have been designed, developed and manufactured in our factory based in Liverpool, England. In the 60 years since then, we've gone on to supply more than 275,000 loading systems.



Manufactured in
GREAT BRITAIN

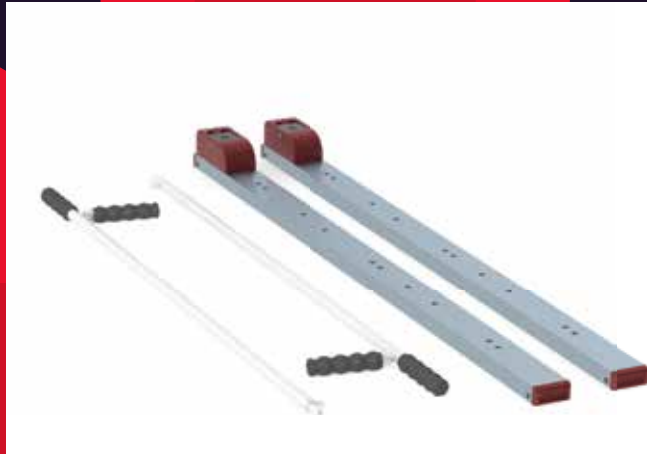

sustainability at the heart

Joloda Hydraroll's Skate & Track systems are environmentally friendly, by nature. Our range of skates are sourced and manufactured with the highest quality grade materials as possible.

Carbon Emissions

Our skates can help to reduce your business's carbon footprint too. We know this as we've documented the reduction of forklift trucks and carbon emissions that businesses use when they adopt our loading and unloading systems.

Packaging

To aid sustainability, we have also carefully planned our skates packaging to be as sustainable as possible too. When you receive our skates, you'll see we've made the conscious effort to reduce the volume of non-recyclable materials.

Aluminium Skate

Whilst our aluminium skate variant is lighter and can help you to reduce carbon emissions, as the vehicle's carrying less additional weight.

In addition, the aluminium skate requires no galvanization or coating as part of the manufacturing process, giving you a lightweight system that ensures corrosion will never be a problem.



skate & track case study

Joloda Hydraroll takes the load off in all loading scenarios. Taplanes is a Harrogate, UK-based bathroom pod manufacturer that serves the hotel and student accommodation market. They approached us to find a solution to help manage the increased demand for their products through faster and more efficient loading.

The Challenge

With a large sector of their business in schools and universities, the company was working in a short window of 6 weeks of the summer holidays to get pods delivered.

Taplanes had a 4m long truck which meant that pods simply and easily slid in and out, however, it was restricting their dispatching process. The business decided to invest in a new Euro 6 spec,

7m long Micra Truck Bodies, however, loading a longer trailer was more strenuous (due to the weight of the pods) they took more time to load and were more susceptible to damage.

The Solution

Joloda Hydraroll proposed a Skate & Track system as it not only provided more efficient loading but also eliminated the risk of product damage. The pods are moved into the vehicle using the skates instead of pushing them in by hand.

The Outcome

Taplanes were able to meet the increase in demand by loading their larger trailer more efficiently and safely and by using a larger vehicle, fewer delivery journeys also meant a reduction in their carbon footprint.



introducing the steel skate

Joloda Hydraroll's steel skate has been continuously developed for over 60 years to deliver a solution to almost any loading scenario. Over the years, we've introduced a variety of different steel skates to meet the ever-changing demands of the market and our clients.

When it comes to handling block pallets or loading devices, our range of Low Lift skates is the go-to solution. Our low lift skates boast a lifting capacity of up to 2,500kg per pair and can handle any regular load. Specifying the right skate for the load or the pallet is essential, as the skate should never exceed the length of the load. The Low Lift Skate range comes in a variety of lengths. The standard lengths vary between 800mm and 1,200mm, whilst special versions of the skate are available in lengths of up to 1,800mm.

Handling paper and cardboard reels is a real challenge and our skates have been utilised by the newspaper and packing industry for decades. Reels are bulky, heavy, are often over 2m tall and are typically transported unpalletised and stood-up. We specifically developed the Heavy-Duty Max Skate for this application. This range of skates boasts a lifting capacity of up to 3,500kg per pair and a lifting height of 19.5mm, which enables the user to manoeuvre them safely. They can also be used in vehicles that are not suitable for forklift traffic.

As standard, the skate is 1,200mm in length, however, on request, special lengths up to 4m are also available. For those who use lightweight vehicles with aluminium tracks, there are special Heavy-Duty Max Skates that feature side rollers.



steel skate technical illustration

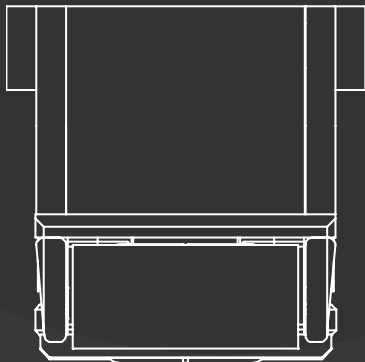
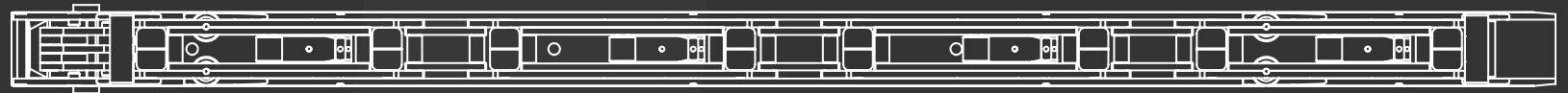
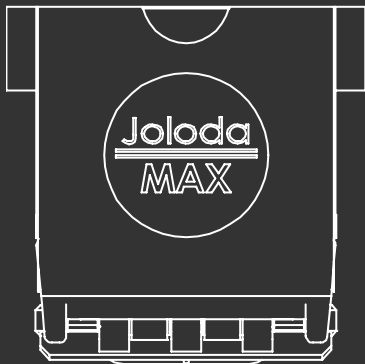

steel skate dimensions

Item Code	Description	Lowered Height (mm)	Lifted Height (mm)	Load Length (mm)	Quantity of Rollers (* / **)	Lifting Capacity (KG)	Weight of a Skate (KG)
LOW LIFT SKATE							
SKL100S301K	1.0m Low Lift Skate Kit	30.8	43.9	1,000	6 / 3	2,500	11.4
SKL100S3J1K	1.0m Low Lift Skate Kit	30.8	43.9	1,000	6 / 3	2,500	11.5
SKL110S301K	1.1m Low Lift Skate Kit	30.8	43.9	1,100	6 / 3	2,500	12.0
SKL110S3J1K	1.1m Low Lift Skate Kit	30.8	43.9	1,100	6 / 3	2,500	12.1
SKL120S301K	1.2m Low Lift Skate Kit	30.8	43.9	1,200	6 / 3	2,500	12.6
SKL120S3J1K	1.2m Low Lift Skate Kit	30.8	43.9	1,200	6 / 3	2,500	12.7
SKL150S301K	1.5m Low Lift Skate Kit	30.8	43.9	1,500	6 / 3	2,500	15.0
SKL150S3J1K	1.5m Low Lift Skate Kit	30.8	43.9	1,500	6 / 3	2,500	15.2
MAX LIFT SKATE							
SKM100S301K	1.0m Max Lift Skate Kit	30.8	49.6	1,000	6 / 3	2,500	11.6
SKM100S302K	1.0m Max Lift Skate Kit	30.8	49.6	1,000	6 / 3	2,500	11.6
SKM100S3J1K	1.0m Max Lift Skate Kit	30.8	49.6	1,000	6 / 3	2,500	11.7

*Track rollers. **Ramp rollers.

steel skate dimensions

Item Code	Description	Lowered Height (mm)	Lifted Height (mm)	Load Length (mm)	Quantity of Rollers (* / **)	Lifting Capacity (KG)	Weight of a Skate (KG)
SKM100S3J2K	1.0m Max Lift Skate Kit	30.8	49.6	1,000	6 / 3	2,500	11.7
SKM110S301K	1.1m Max Lift Skate Kit	30.8	49.6	1,100	6 / 3	2,500	12.0
SKM110S302K	1.1m Max Lift Skate Kit	30.8	49.6	1,100	6 / 3	2,500	12.0
SKM110S3J1K	1.1m Max Lift Skate Kit	30.8	49.6	1,100	6 / 3	2,500	12.3
SKM110S3J2K	1.1m Max Lift Skate Kit	30.8	49.6	1,100	6 / 3	2,500	12.3
SKM120S301K	1.2m Max Lift Skate Kit	30.8	49.6	1,200	6 / 3	2,500	12.7
SKM120S302K	1.2m Max Lift Skate Kit	30.8	49.6	1,200	6 / 3	2,500	12.7
SKM120S3J1K	1.2m Max Lift Skate Kit	30.8	49.6	1,200	6 / 3	2,500	13.0
SKM120S3J2K	1.2m Max Lift Skate Kit	30.8	49.6	1,200	6 / 3	2,500	13.0
HEAVY-DUTY SKATES							
SKL120H4010K	1.2m Heavy-Duty Max Lift Skate Kit	30.8	43.9	1,200	8 / 4	3,500	13.2
SKM120H4010K	1.2m Heavy-Duty Max Lift Skate Kit	30.8	49.6	1,200	8 / 4	3,500	13.4

*Track rollers. **Ramp rollers.

introducing the aluminium skate

At Joloda Hydraroll, we are continually developing our range of skates. Our range of steel skates offer loading solutions for the heaviest of loads, however many other pallet loads don't exceed 1,000kg and they can be handled by a lightweight skate.

We identified this niche in the transportation industry for a lightweight solution, thus the Aluminium Skate was born and launched in 2022.

The Aluminium Skate was initially launched with a length of 1,100mm, which is the standard pallet length in most Asian countries.

It is the most accessible and easy to use skate to date. It weighs just

7kg and is capable of safely lifting payloads of 1,600kg, which is the highest lifting capacity in the market. It helps both operators in everyday use and saves costs in transportation.

Our skates deliver unprecedented levels of durability and reliability, which you've come to expect from our products.

We are also continuing to develop new varieties of our Aluminium Skate too, including longer skates and headless skates, which allow the user to benefit from much faster loading times as they'll allow the user to pick up the next pallet without having to wait for the forklift to lift the pallet first.



aluminium skate technical illustration

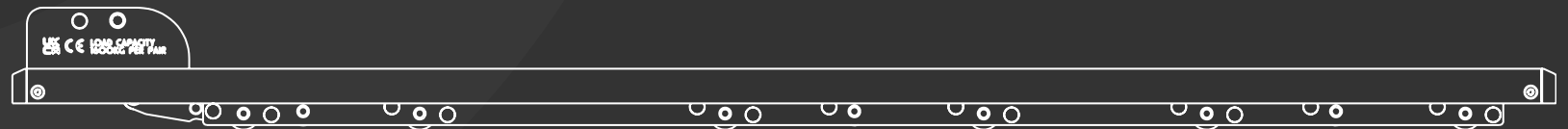
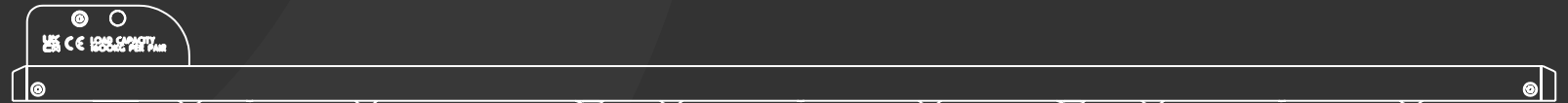
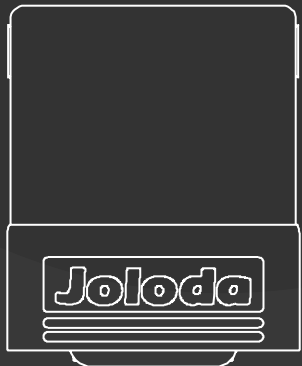
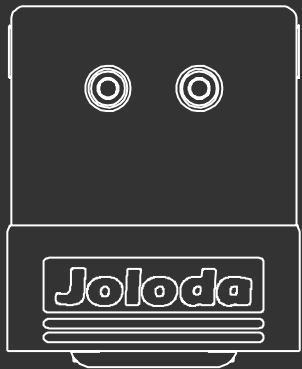

aluminium skate dimensions

Item Code	Description	Lowered Height (mm)	Lifted Height (mm)	Load Length (mm)	Quantity of Rollers (* / **)	Lifting Capacity (KG)	Weight of a Skate (KG)
SAS110A3080K	1.1m Aluminium Skate Kit	31.1	48.1	1,100	6 / 3	1,600	7.1

*Track rollers. **Ramp rollers.



Watch now,
scan here.

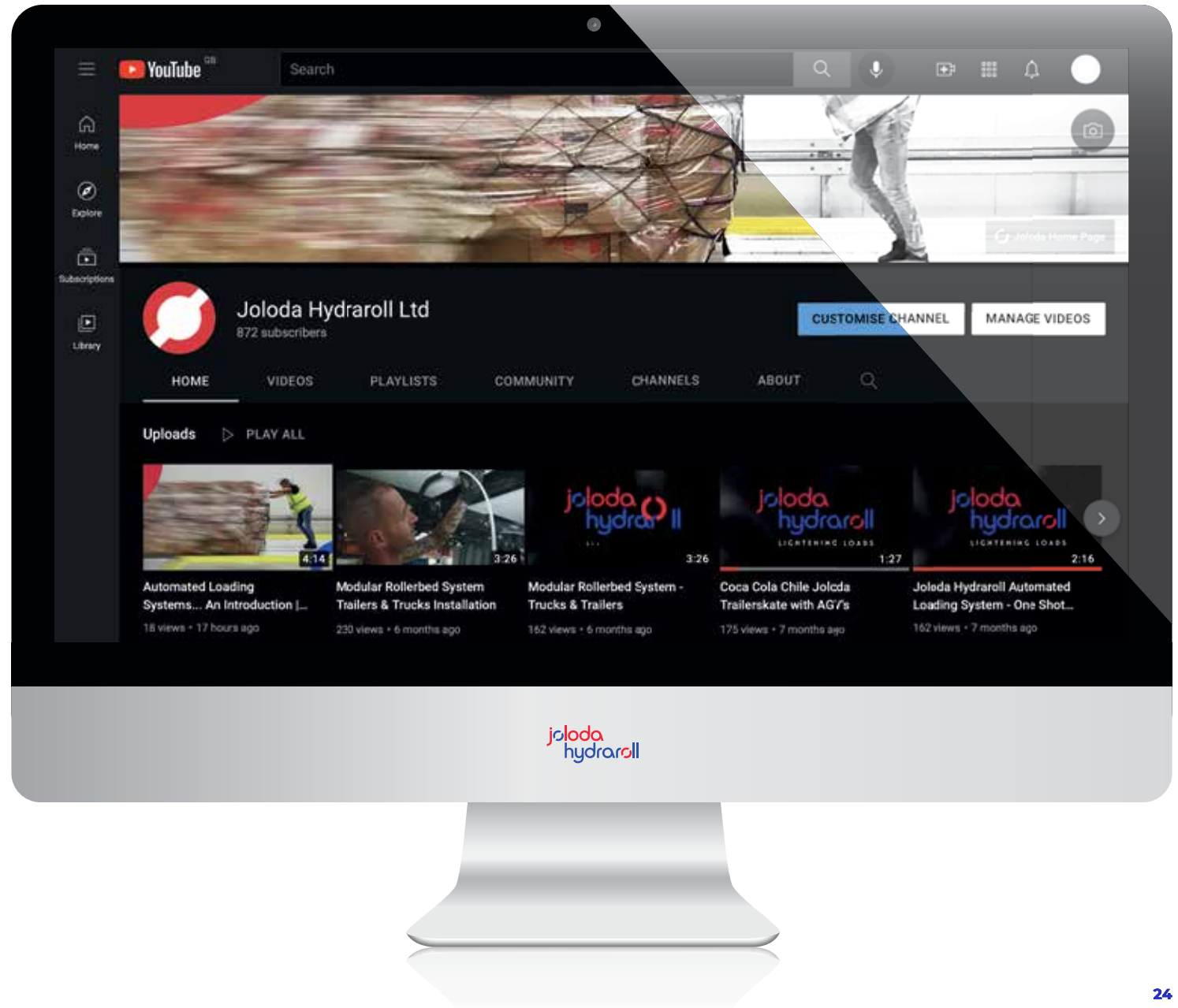

why choose us?

We're much more than 'off-the-shelf'. We're the creators, the experts and we're here to help streamline your logistics and create the ideal loading solutions for your loading problems.



about us

We help businesses lighten loads.
We are highly regarded as the world's leading loading and unloading solutions provider in the logistics industry.

Over the last 60 years, we've helped thousands of businesses streamline their logistics operations to be more cost-efficient, more sustainable, and more health and safety-conscious.

As experts in all kinds of unloading and unloading solutions, we can help innovate, automate and streamline your end-of-production line problems, wherever you are.

We work with a network of over 30 global distributors to provide you with

comprehensive design, installation, maintenance, and certification services across a range of industry sectors.

We have installed more than 500,000 loading systems and through our extensive knowledge and expertise, we inspire change and make manual loading solutions more efficient and effective.

We are the world leaders in loading solutions, and we're here to lighten your load.



a global leader, with local partners



Europe

- Belgium
- Czech Republic
- France
- Germany
- Iceland
- Italy
- Netherlands
- Poland
- Portugal
- Spain
- Sweden
- UK

Asia

- Dubai
- India
- Japan
- Korea
- Malaysia
- Saudi Arabia
- Taiwan
- Thailand
- Turkey

Africa

- Egypt
- South Africa

Americas

- Argentina
- Brazil
- Chile
- Mexico
- USA

Oceania

- Australia

if you have any questions, please get in touch!

joloda
hydraroll

LIGHTENING LOADS

WORKING IN
PARTNERSHIP WITH



lightening loads across the world

joloda.com

Southern States Group

4-6 Burns Road, Altona
VIC 3018, Australia
+61 3 8689 7111
info@ssgroup.com.au

Joloda Hydraroll Ltd (Head Office)

1 De Havilland Drive, Liverpool
L24 8RN, United Kingdom
+44 151 427 8954
hello@joloda.com

Joloda BV (European Office)

De Hulst 13, 5807 EW, Oostrum
Venray, The Netherlands
+31 478 501 059
sales@joloda.nl

Joloda Loading Automation (USA Office)

PO Box 4820, Wilmington
North Carolina, 28406, USA
+1 910 791 2125
brett.murrill@loading-automation.com

Joloda Hydraroll SAS (French Office)

1 Cour du Havre, CS50101
75008 Paris, France
+ 33 7 81 41 99 00
jbalsemin@joloda.com